



<ORIGINAL>

Mr. SLIM

Air-Conditioners

PEAD-M50, 60, 71, 100, 125, 140JAA (D)

INSTALLATION MANUAL

FOR INSTALLER

For safe and correct use, please read this installation manual thoroughly before installing the air-conditioner unit.

English

[Fig. 3-1-1]

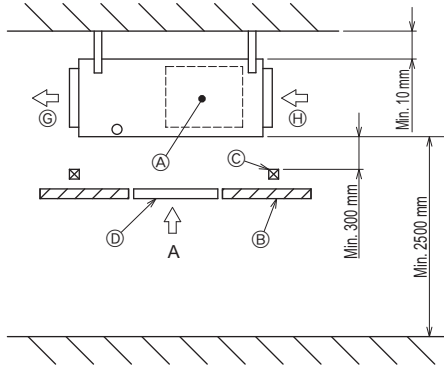

[Fig. 3-1-2]

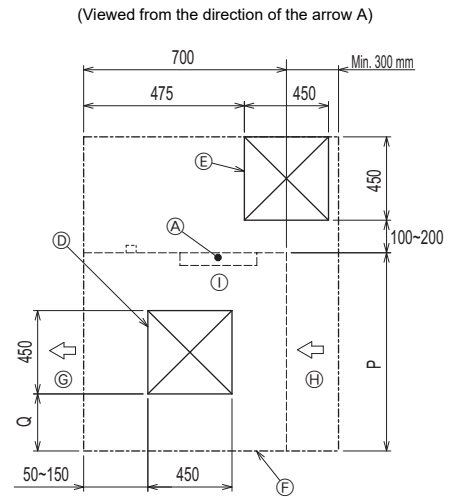

[Fig. 3-1-3]

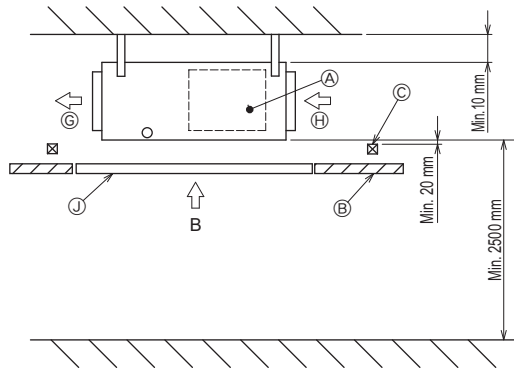

[Fig. 3-1-4]

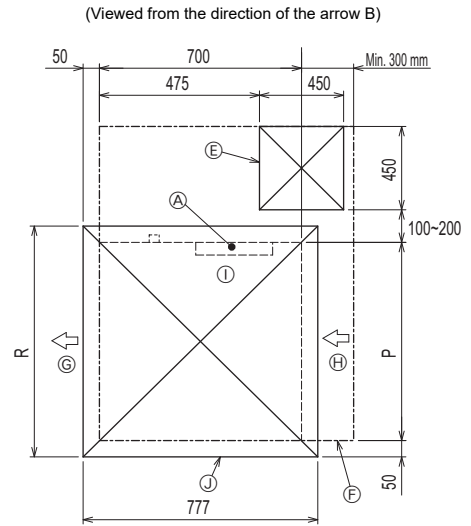

[Fig. 3-1-5]

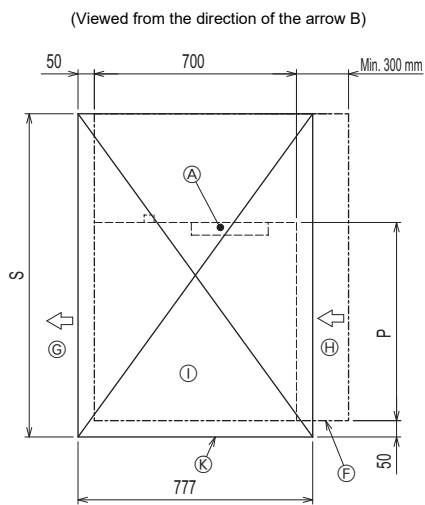

- (A) Electric box
- (B) Ceiling
- (C) Ceiling beam
- (D) Access door 2 (450 x 450)
- (E) Access door 1 (450 x 450)
- (F) Maintenance access space
- (G) Supply air
- (H) Intake air
- (I) Bottom of indoor unit
- (J) Access door 3
- (K) Access door 4

Model	(mm)			
	P	Q	R	S
PEAD-M50	900	150~250	1000	1500
PEAD-M60, 71	1100	250~350	1200	1700
PEAD-M100, 125	1400	400~500	1500	2000
PEAD-M140	1600	500~600	1700	2200

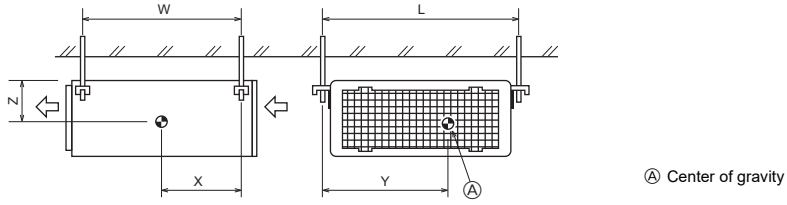
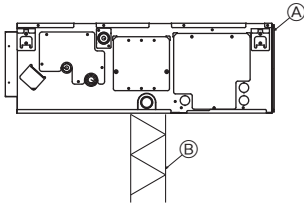
4**4.1****[Fig. 4-1]****5****5.1****[Fig. 5-1-1]**

- Ⓐ Unit body
- Ⓑ Lifting machine

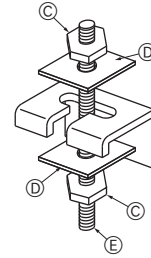
[Fig. 5-1-2]

- Ⓒ Nuts (field supply)
- Ⓓ Washers (accessory)
- Ⓔ M10 hanging bolt (field supply)

[Fig. 6-1]

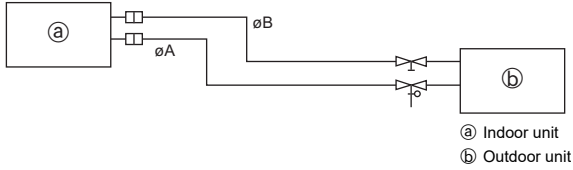

Available pipe size

	(mm)		
	M50	M60	M71 – 140
Liquid side (B)	ø 6.35 O	ø 6.35	–
Gas side (A)	ø 12.7 O	ø 15.88 O	ø 15.88 O

O: Factory flare nut attachment to the heat exchanger.

Remark: Use correct flare nuts meeting the pipe size of the outdoor unit.

6.2

[Fig. 6-2-1]

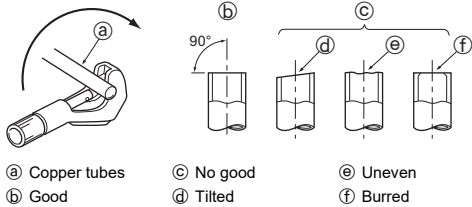

- a Copper tubes
- b Good
- c No good
- d Tilted
- e Uneven
- f Burred

[Fig. 6-2-2]

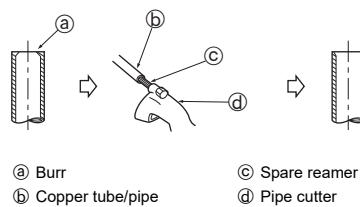

- a Burr
- b Copper tube/pipe
- c Spare reamer
- d Pipe cutter

[Fig. 6-2-3]

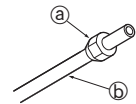

- a Flare nut
- b Copper tube

[Fig. 6-2-4]

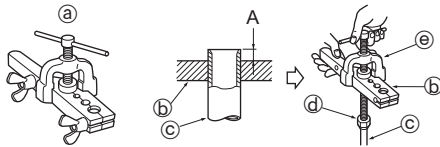

- a Flaring tool
- b Die
- c Copper tube
- d Flare nut
- e Yoke

[Fig. 6-2-5]

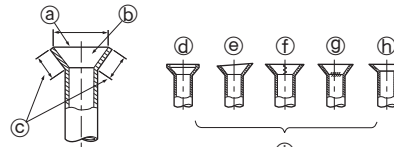

- a Smooth all around
- b Inside is shining without any scratches
- c Even length all around
- d Too much
- e Cracked
- f Tilted
- g Scratch on flared plane
- h Uneven
- i Bad examples

6.3

[Fig. 6-3-1]

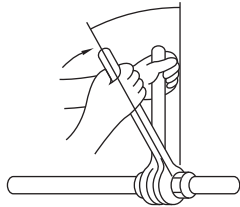

[Fig. 6-3-2]

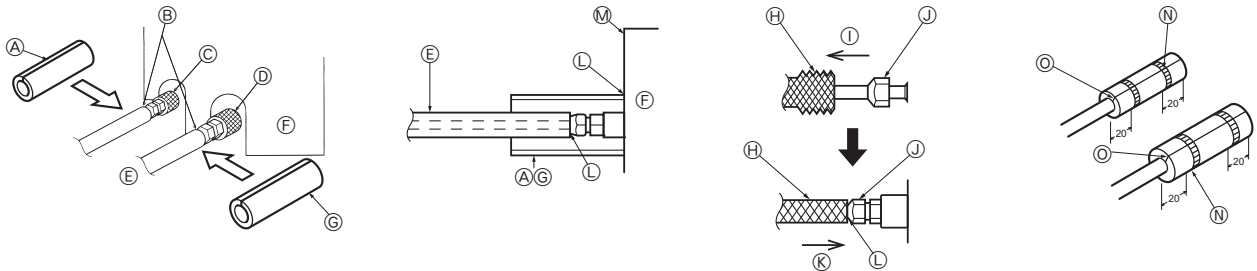

- A Pipe cover (small) (accessory)
- B Caution: Pull out the thermal insulation on the refrigerant piping at the site, insert the flare nut to flare the end, and replace the insulation in its original position. Take care to ensure that condensation does not form on exposed copper piping.
- C Liquid end of refrigerant piping
- D Gas end of refrigerant piping
- E Site refrigerant piping
- F Main body
- G Pipe cover (large) (accessory)
- H Thermal insulation (field supply)
- I Pull
- J Flare nut
- K Return to original position
- L Ensure that there is no gap here
- M Plate on main body
- N Band (accessory)
- O Ensure that there is no gap here. Place join upwards.

[Fig. 6-5-1]

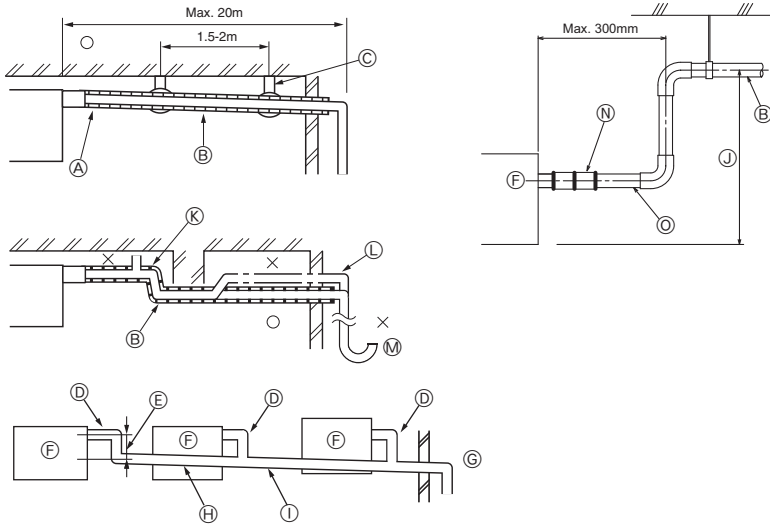

- Correct piping
 - × Wrong piping
 - Ⓐ Insulation (9 mm or more)
 - Ⓑ Downward slope (1/100 or more)
 - Ⓒ Support metal
 - Ⓚ Air bleeder
 - Ⓛ Raised
 - Ⓜ Odor trap
- Grouped piping
- Ⓓ O. D. ø32 PVC TUBE
 - Ⓔ Make it as large as possible. About 10 cm.
 - Ⓕ Indoor unit
 - Ⓖ Make the piping size large for grouped piping.
 - Ⓗ Downward slope (1/100 or more)
 - Ⓛ O. D. ø38 PVC TUBE for grouped piping. (9 mm or more insulation)
- PEAD-M·JAAD model
- Ⓜ Up to 700 mm
 - Ⓝ Drain hose (accessory)
 - Ⓞ Horizontal or slightly upgradient

[Fig. 6-5-2]

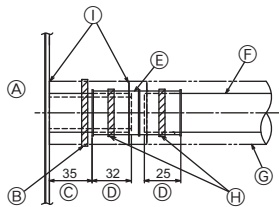

- Ⓐ Indoor unit
 - Ⓑ Tie band (accessory)
 - Ⓒ Visible part
 - Ⓓ Insertion margin
 - Ⓔ Drain hose (accessory)
 - Ⓕ Drain pipe (O.D. ø32 PVC TUBE, field supply)
 - Ⓖ Insulating material (field supply)
 - Ⓗ Tie band (accessory)
- ① To be gap free. The joint section of the insulation material meet must be at the top.

[Fig. 6-5-3]

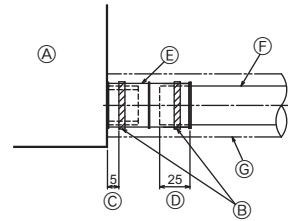

- Ⓐ Indoor unit
- Ⓑ Tie band (accessory)
- Ⓒ Band fixing part
- Ⓓ Insertion margin
- Ⓔ Drain socket (accessory)
- Ⓕ Drain pipe (O.D. ø32 PVC TUBE, field supply)
- Ⓖ Insulating material (field supply)

[Fig. 6-6]

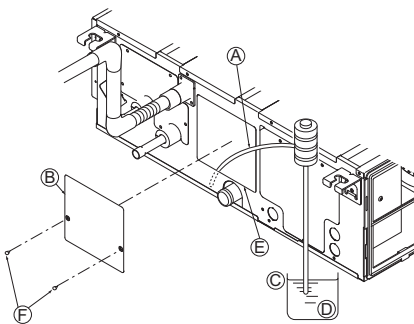

- Ⓐ Insert pump's end 2 to 4 cm.
- Ⓑ Remove the water supply port.
- Ⓒ About 2500 cc
- Ⓓ Water
- Ⓔ Filling port
- Ⓕ Screw

[Fig. 7-1]

<A> In case of rear inlet

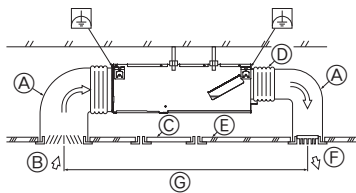

- Ⓐ Duct
- Ⓑ Air inlet
- Ⓒ Access door
- Ⓓ Canvas duct
- Ⓔ Ceiling surface
- Ⓕ Air outlet
- Ⓖ Leave distance enough to prevent short cycle

 In case of bottom inlet

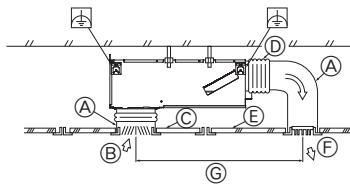

[Fig. 7-2]

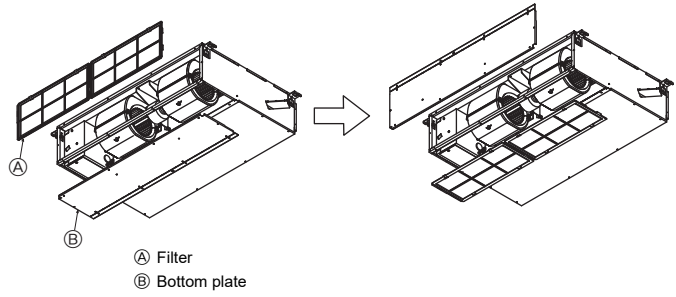

- Ⓐ Filter
- Ⓑ Bottom plate

[Fig. 7-3]

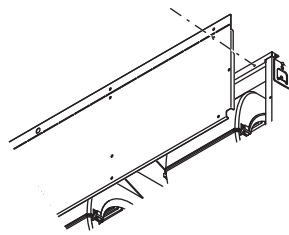

[Fig. 7-4]

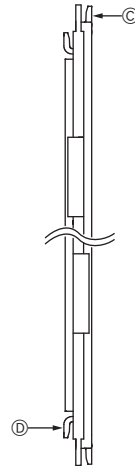

- Ⓒ Nail for the bottom inlet
- Ⓓ Nail for the rear inlet

8.1

[Fig. 8-1-1]

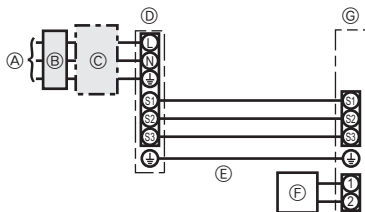

- Ⓐ Outdoor unit power supply
- Ⓑ Earth leakage breaker
- Ⓒ Wiring circuit breaker or isolating switch
- Ⓓ Outdoor unit
- Ⓔ Indoor unit/outdoor unit connecting cords
- Ⓕ Remote controller (option)
- Ⓖ Indoor unit

[Fig. 8-1-2]

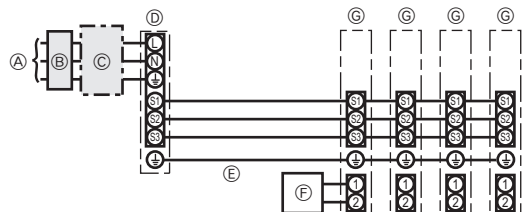

- Ⓐ Outdoor unit power supply
- Ⓑ Earth leakage breaker
- Ⓒ Wiring circuit breaker or isolating switch
- Ⓓ Outdoor unit
- Ⓔ Indoor unit/outdoor unit connecting cords
- Ⓕ Remote controller (option)
- Ⓖ Indoor unit

[Fig. 8-1-3]

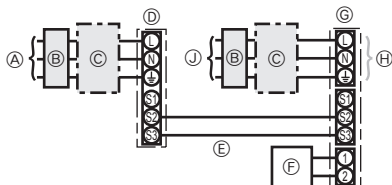

- Ⓐ Outdoor unit power supply
- Ⓑ Earth leakage breaker
- Ⓒ Wiring circuit breaker or isolating switch
- Ⓓ Outdoor unit
- Ⓔ Indoor unit/outdoor unit connecting cords
- Ⓕ Remote controller (option)
- Ⓖ Indoor unit
- Ⓗ Option
- Ⓙ Indoor unit power supply

[Fig. 8-1-4]

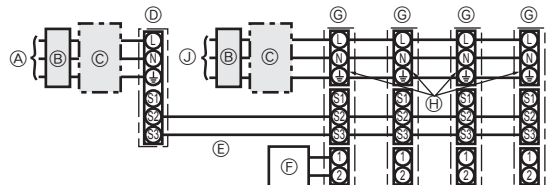

- Ⓐ Outdoor unit power supply
- Ⓑ Earth leakage breaker
- Ⓒ Wiring circuit breaker or isolating switch
- Ⓓ Outdoor unit
- Ⓔ Indoor unit/outdoor unit connecting cords
- Ⓕ Remote controller (option)
- Ⓖ Indoor unit
- Ⓗ Option
- Ⓙ Indoor unit power supply

[Fig. 8-2-1]

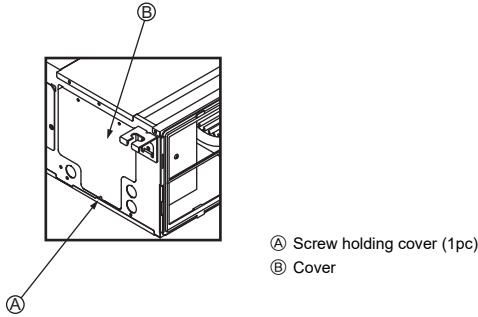

[Fig. 8-2-2]

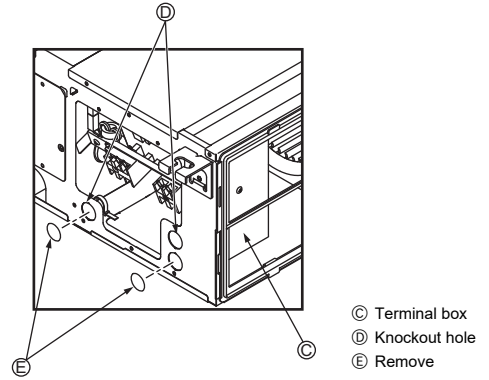

[Fig. 8-2-3]

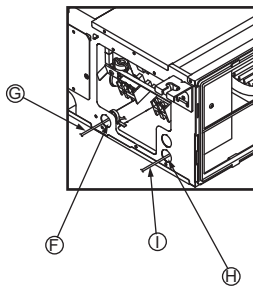

[Fig. 8-2-4]

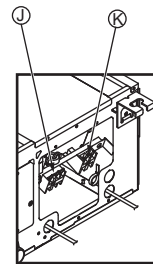

- ⓕ Use PG bushing to keep the weight of the cable and external force from being applied to the power supply terminal connector. Use a cable tie to secure the cable.
- ⓐ Power source wiring
- ⓓ Use ordinary bushing
- ⓑ Transmission wiring

- ⓙ Terminal block for power source and indoor transmission
- Ⓚ Terminal block for remote controller

[Fig. 8-2-5]

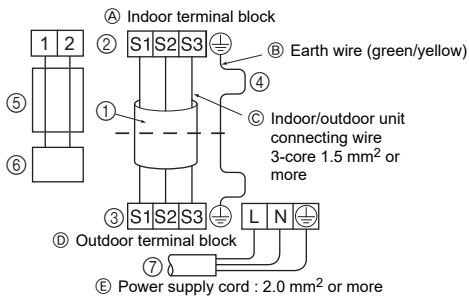

- ⓐ Indoor terminal block
- ⓑ Earth wire (green/yellow)
- ⓒ Indoor/outdoor unit connecting wire 3-core 1.5 mm² or more
- ⓓ Outdoor terminal block
- ⓔ Power supply cord: 2.0 mm² or more
- ① Connecting cable
Cable 3-core 1.5 mm², in conformity with Design 245 IEC 57.
- ② Indoor terminal block
- ③ Outdoor terminal block

- ④ Always install an earth wire (1-core 1.5 mm²) longer than other cables
- ⑤ Remote controller cable
Wire No × size (mm²) : Cable 2C × 0.3
This wire accessory of remote controller (wire length : 10m, non-polar. Max. 500m)
- ⑥ Wired remote controller (option)
- ⑦ Power supply cord
Cable 3-core 2.0 mm² or more, in conformity with Design 245 IEC 57.

[Fig. 8-4-1]

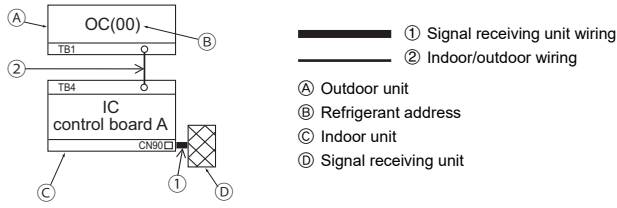

[Fig. 8-4-2]

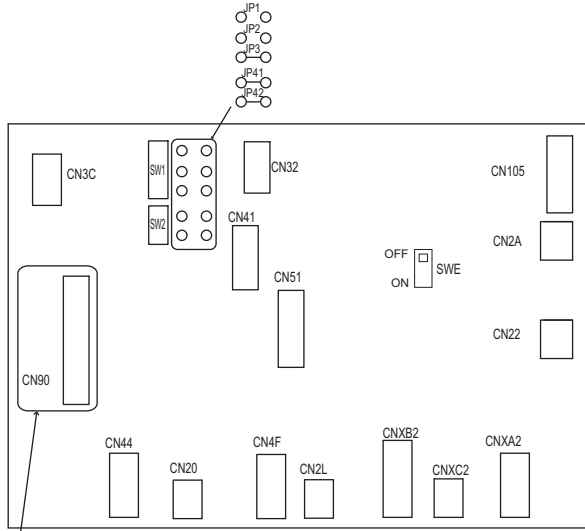

Ⓐ CN90: Connector for remote controller wire connection

<Indoor controller board>

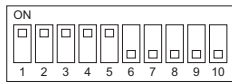

Ⓑ The figure at left shows that the switches 1 through 5 are set to ON and 6 through 10 are set to OFF.

[Fig. 8-4-3]

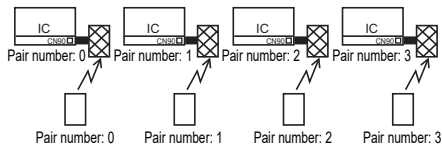

[Fig. 8-4-4]

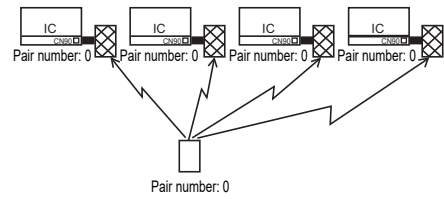

[Fig. 8-4-5]

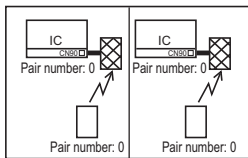

[Fig. 8-5-1]

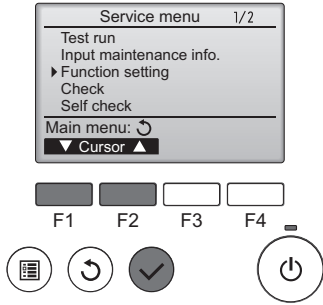

[Fig. 8-5-2]

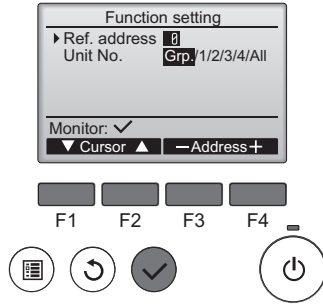

[Fig. 8-5-3]

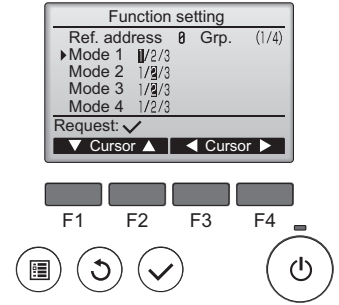

[Fig. 8-5-4]

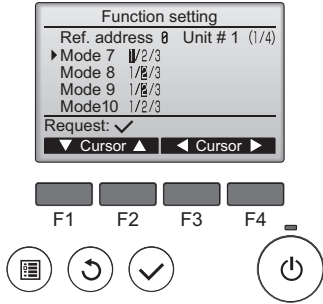

[Fig. 8-5-5]

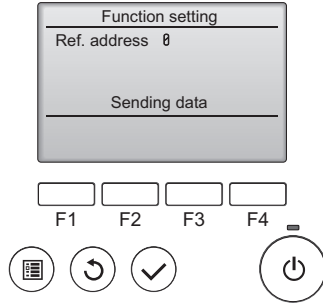

[Fig. 8-5-6]

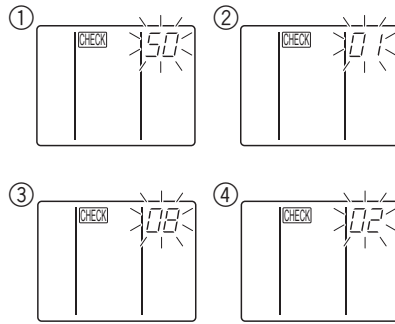
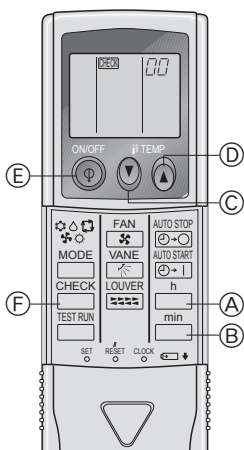

- Ⓐ Hour button
- Ⓑ Minute button
- Ⓒ TEMP button
- Ⓓ TEMP button
- Ⓔ ON/OFF button
- Ⓕ CHECK button

[Fig. 9-2-1]

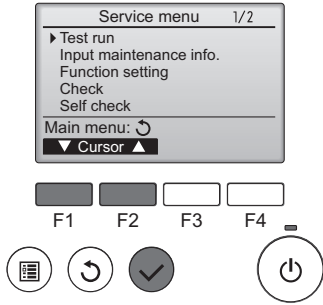

[Fig. 9-2-2]

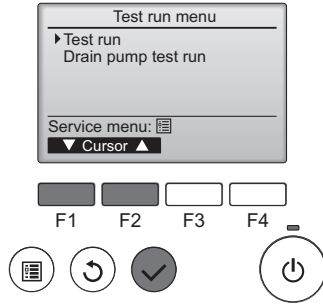

[Fig. 9-2-3]

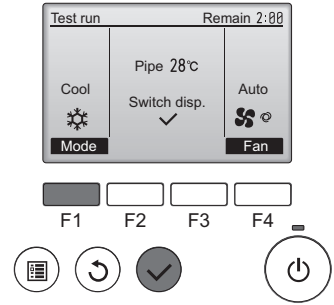

[Fig. 9-2-4]

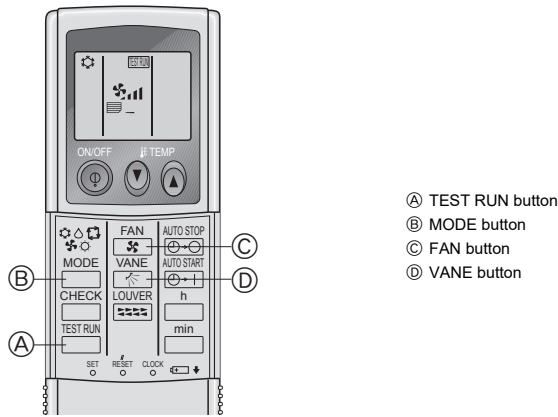

- Ⓐ TEST RUN button
- Ⓑ MODE button
- Ⓒ FAN button
- Ⓓ VANE button

[Fig. 10-1]

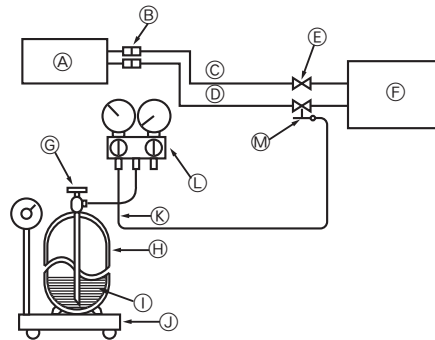

- Ⓐ Indoor unit
- Ⓑ Union
- Ⓒ Liquid pipe
- Ⓓ Gas pipe
- Ⓔ Stop valve
- Ⓕ Outdoor unit
- Ⓖ Refrigerant gas cylinder operating valve
- Ⓗ Refrigerant gas cylinder for R32/R410A with siphon
- Ⓙ Refrigerant (liquid)
- ⓫ Electronic scale for refrigerant charging
- ⓬ Charge hose (for R32/R410A)
- ⓭ Gauge manifold valve (for R32/R410A)
- ⓯ Service port

Contents





1. Safety precautions	11	6. Refrigerant piping work	13
2. Selecting the installation location	12	7. Duct work	16
3. Selecting an installation site & Accessories	12	8. Electrical work	17
4. Fixing hanging bolts	13	9. Test run	21
5. Installing the unit	13	10. Maintenance	24

Note:
The phrase "Wired remote controller" in this installation manual refers only to the PAR-33MAA. If you need any information for the other remote controller, please refer to either the installation manual or initial setting manual which are included with the remote controller.

1. Safety precautions

- ▶ Before installing the unit, make sure you read all the "Safety Precautions".
- ▶ The "Safety Precautions" provide very important points regarding safety. Make sure you follow them.
- ▶ Please report to or take consent by the supply authority before connection to the system.

MEANINGS OF SYMBOLS ON THE UNIT

	WARNING (Risk of fire)	This symbol is only for R32 refrigerant. The type of the refrigerant used is written on the nameplate on the outdoor unit. R32 refrigerant is flammable. If the refrigerant leaks, or comes in contact with fire or parts that generate heat, it may create harmful gas and pose a risk of fire.
		Read the OPERATION MANUAL carefully before operation.
		Service personnel are required to carefully read the OPERATION MANUAL and INSTALLATION MANUAL before operation.
		Further information is available in the OPERATION MANUAL, INSTALLATION MANUAL, and the like.

- Please report to or take consent by the supply authority before connection to the system.
- Be sure to read "Safety precautions" before installing the air conditioner.
- Be sure to observe the cautions specified here as they include important items related to safety.
- The indications and meanings are as follows.







 **Warning:**
Could lead to death, serious injury, etc.

 **Caution:**
Could lead to serious injury in particular environments when operated incorrectly.

- After reading this manual, be sure to keep it together with the instruction manual in a handy place on the customer's site.

-  **Warning:**
- Do not install it by yourself (customer).
Incomplete installation could cause injury due to fire, electric shock, the unit falling or leakage of water. Consult the dealer from whom you purchased the unit or special installer.
 - This appliance is not intended for use by persons (including children) with reduced physical, sensory or mental capabilities, or lack of experience and knowledge, unless they have been given supervision or instruction concerning use of the appliance by a person responsible for their safety.
 - Install the unit securely in a place which can bear the weight of the unit.
When installed in an insufficient strong place, the unit could fall causing injured.
 - Use the specified wires to connect the indoor and outdoor units securely and attach the wires firmly to the terminal board connecting sections so the stress of the wires is not applied to the sections.
Incomplete connecting and fixing could cause fire.
 - Do not use intermediate connection of the power cord or the extension cord and do not connect many devices to one AC outlet.
It could cause a fire or an electric shock due to defective contact, defective insulation, exceeding the permissible current, etc.
 - Check that the refrigerant gas does not leak after installation has completed.
 - Perform the installation securely referring to the installation manual.
Incomplete installation could cause a personal injury due to fire, electric shock, the unit falling or leakage of water.
 - This appliance is intended to be used by expert or trained users in shops, in light industry and on farms, or for commercial use by lay persons.
 - Perform electrical work according to the installation manual and be sure to use an exclusive circuit.
If the capacity of the power circuit is insufficient or there is incomplete electrical work, it could result in a fire or an electric shock.
 - If the supply cord is damaged, it must be replaced by the manufacturer, its service agent or similarly qualified persons in order to avoid a hazard.
 - Attach the electrical part cover to the indoor unit and the service panel to the outdoor unit securely.
If the electrical part cover in the indoor unit and/or the service panel in the

Symbols put on the unit

-  : Indicates an action that must be avoided.
-  : Indicates that important instructions must be followed.
-  : Indicates a part which must be grounded.
-  : Indicates that caution should be taken with rotating parts.
-  : Indicates that the main switch must be turned off before servicing.
-  : Beware of electric shock.
-  : Beware of hot surface.

 **Warning:**
Carefully read the labels affixed to the main unit.

- outdoor unit are not attached securely, it could result in a fire or an electric shock due to dust, water, etc.
- Be sure to use the part provided or specified parts for the installation work.
The use of defective parts could cause an injury or leakage of water due to a fire, an electric shock, the unit falling, etc.
- Ventilate the room if refrigerant leaks during operation.
If the refrigerant comes in contact with a flame, poisonous gases will be released.
- Children should be supervised to ensure that they do not play with the appliance.
- When installing, relocating, or servicing the air conditioner, use only the specified refrigerant written on the outdoor unit to charge the refrigerant lines. Do not mix the refrigerant with any other refrigerant, and do not allow air to remain in the lines.
 - If air is mixed with the refrigerant, then it may cause abnormal high pressure in the refrigerant lines, resulting in an explosion and other hazards.
 - The use of any refrigerant other than that specified for the system will cause mechanical failure, system malfunction, or unit breakdown. In the worst case, this could lead to a serious impediment to securing product safety.
 - It may also be in violation of applicable laws.
 - MITSUBISHI ELECTRIC CORPORATION cannot be held responsible for malfunctions or accidents resulting from the use of the wrong type of refrigerant.
- This indoor unit should be installed in a room which is equal to or larger than the floor space specified in the outdoor unit installation manual.
- Only use means recommended by the manufacturer to accelerate the defrosting process or to clean.
- This indoor unit shall be stored in a room that has no continuously-operating ignition device such as open flame, gas appliance, or electrical heater.
- Do not pierce a hole in or burn this indoor unit or refrigerant lines.
- Be aware that the refrigerant may be odour-free.
- Pipe-work shall be protected from physical damage.
- The installation of pipe-work shall be kept to a minimum.
- Compliance with national gas regulations shall be observed.
- Keep any required ventilation openings clear of obstruction.

1. Safety precautions

- Do not use low temperature solder alloy when brazing the refrigerant pipes.
- When performing brazing work, be sure to ventilate the room sufficiently. Make sure that there are no hazardous or flammable materials nearby. When performing the work in a closed room, small room, or similar location, make sure that there are no refrigerant leaks before performing the work. If refrigerant leaks and accumulates, it may ignite or poisonous gases may be released.
- The installer and system specialist shall secure safety against leakage according to local regulation or standards.
 - The instructions in this manual may be applicable if local regulation are not available.
- Pay a special attention to the place, such as a basement, etc. where refrigeration gas can stay, since refrigeration is heavier than the air.
- For installation and relocation work, follow the instructions in the installation manual and use tools and pipe components specifically made for using with refrigerant specified in the outdoor unit installation manual.
- If the air conditioner is installed in a small room or closed room, measures must be taken to prevent the refrigerant concentration in the room from exceeding the safety limit in the event of refrigerant leakage. Should the refrigerant leak and cause the concentration limit to be exceeded, hazards due to lack of oxygen in the room may result.

⚠ Caution:

- **Perform grounding.**
Do not connect the ground wire to a gas pipe, water pipe arrester or telephone ground wire. Defective grounding could cause an electric shock.
- Do not install the unit in a place where an inflammable gas leaks.
If gas leaks and accumulates in the area surrounding the unit, it could cause an explosion.
- Install a ground leakage breaker depending on the installation place (where it is humid).
If a ground leakage breaker is not installed, it could cause an electric shock.

- Perform the drainage/piping work securely according to the installation manual.
If there is a defect in the drainage/piping work, water could drop from the unit and household goods could be wet and damaged.
- Fasten a flare nut with a torque wrench as specified in this manual.
When fastened too tight, a flare nut may be broken after a long period and cause a leakage of refrigerant.

2. Selecting the installation location

2.1. Indoor unit

- Where airflow is not blocked.
- Where cool air spreads over the entire room.
- Where it is not exposed to direct sunshine.
- At a distance 1 m or more away from your TV and radio (to prevent picture from being distorted or noise from being generated).
- In a place as far away as possible from fluorescent and incandescent lights (so the infrared remote control can operate the air conditioner normally).
- Where the air filter can be removed and replaced easily.

⚠ Warning:

Mount the indoor unit into a ceiling strong enough to withstand the weight of the unit.

2.2. Outdoor unit

- Where it is not exposed to strong wind.
- Where airflow is good and dustless.
- Where it is not exposed to rain and direct sunshine.
- Where neighbours are not annoyed by operation sound or hot air.
- Where rigid wall or support is available to prevent the increase of operation sound or vibration.
- Where there is no risk of combustible gas leakage.
- When installing the unit at a high level, be sure to fix the unit legs.
- Where it is at least 3 m away from the antenna of TV set or radio. (Otherwise, images would be disturbed or noise would be generated.)
- Install the unit horizontally.

⚠ Caution:

Avoid the following places for installation where air conditioner trouble is liable to occur.

- Where there is too much machine oil.
- Salty environment as seaside areas.
- Hot-spring areas.
- Where sulfide gas exists.
- Other special atmospheric areas.

3. Selecting an installation site & Accessories

- Select a site with sturdy fixed surface sufficiently durable against the weight of unit.
 - Before installing unit, the routing to carry in unit to the installation site should be determined.
 - Select a site where the unit is not affected by entering air.
 - Select a site where the flow of supply and return air is not blocked.
 - Select a site where refrigerant piping can easily be led to the outside.
 - Select a site which allows the supply air to be distributed fully in room.
 - Do not install unit at a site with oil splashing or steam in much quantity.
 - Do not install unit at a site where combustible gas may generate, flow in, stagnate or leak.
 - Do not install unit at a site where equipment generating high frequency waves (a high frequency wave welder for example) is provided.
 - Do not install unit at a site where fire detector is located at the supply air side. (Fire detector may operate erroneously due to the heated air supplied during heating operation.)
 - When special chemical product may scatter around such as site chemical plants and hospitals, full investigation is required before installing unit. (The plastic components may be damaged depending on the chemical product applied.)
 - If the unit is run for long hours when the air above the ceiling is at high temperature/high humidity (dew point above 26 °C), dew condensation may be produced in the indoor unit. When operating the units in this condition, add insulation material (10-20 mm) to the entire surface of the indoor unit to avoid dew condensation.
- (1) When a space of 300 mm or more is available below the unit between the unit and the ceiling. **[Fig. 3-1-1]**
- Create access door 1 and 2 (450 x 450 mm each) as shown in [Fig. 3-1-2]. (Access door 2 is not required if enough space is available below the unit for a maintenance worker to work in.)
- (2) When a space of less than 300 mm is available below the unit between the unit and the ceiling. (At least 20 mm of space should be left below the unit as shown in [Fig. 3-1-3].)
- Create access door 1 diagonally below the electric box and access door 3 below the unit as shown in [Fig. 3-1-4].
or
 - Create access door 4 below the electric box and the unit as shown in [Fig. 3-1-5].

[Fig. 3-1-1] (P.2)

[Fig. 3-1-2] (Viewed from the direction of the arrow A) (P.2)

[Fig. 3-1-3] (P.2)

[Fig. 3-1-4] (Viewed from the direction of the arrow B) (P.2)

[Fig. 3-1-5] (Viewed from the direction of the arrow B) (P.2)

- | | |
|-----------------------------|-------------------------|
| Ⓐ Electric box | Ⓒ Supply air |
| Ⓑ Ceiling | Ⓓ Intake air |
| Ⓒ Ceiling beam | Ⓔ Bottom of indoor unit |
| Ⓓ Access door 2 (450 x 450) | Ⓕ Access door 3 |
| Ⓔ Access door 1 (450 x 450) | Ⓖ Access door 4 |
| Ⓕ Maintenance access space | |

⚠ Warning:

- The unit must be securely installed on a structure that can sustain its weight. If the unit is mounted on an unstable structure, it may fall down causing injuries.
- This unit should be installed in rooms which exceed the floor space specified in outdoor unit installation manual. Refer to outdoor unit installation manual.
- Install the indoor unit at least 2.5m above floor or ground level. For appliances not accessible to the general public.
- Refrigerant pipes connection shall be accessible for maintenance purpose.

3. Selecting an installation site & Accessories

3.2. Securing installation and service space

- Select the optimum direction of supply airflow according to the configuration of the room and the installation position.
- As the piping and wiring are connected at the bottom and side surfaces, and the maintenance is made at the same surfaces, allow a proper space properly. For the efficient suspension work and safety, provide a space as much as possible.

3.3. Indoor unit accessories

The unit is provided with the following accessories:

No.	Name	Quantity
①	Pipe cover (for refrigerant piping joint) Small diameter	1
②	Pipe cover (for refrigerant piping joint) Large diameter	1
③	Bands for temporary tightening of pipe cover and drain hose	7 (8)
④	Washer	8
⑤	Drain hose	1

The values in the parenthesis are for the PEAD-M·JAAD model.

4. Fixing hanging bolts

4.1. Fixing hanging bolts

[Fig. 4-1] (P.3)

- Ⓐ Center of gravity

(Give site of suspension strong structure.)

Hanging structure

- Ceiling: The ceiling structure varies from building to one another. For detailed information, consult your construction company.

Center of gravity and Product Weight

Model name	W	L	X	Y	Z	Product Weight (kg)
PEAD-M50JAA(D)	643	954	340	375	130	26(27)
PEAD-M60, 71JAA(D)	643	1154	325	525	130	29(30)
PEAD-M100JAA(D)	643	1454	330	675	130	38(39)
PEAD-M125JAA(D)	643	1454	330	675	130	39(40)
PEAD-M140JAA(D)	643	1654	332	725	130	43(44)

The values in the parenthesis are for the PEAD-M·JAAD model.

- If necessary, reinforce the hanging bolts with anti-quake supporting members as countermeasures against earthquakes.

* Use M10 for hanging bolts and anti-quake supporting members (field supply).

- ① Reinforcing the ceiling with additional members (edge beam, etc.) must be required to keep the ceiling at level and to prevent the ceiling from vibrations.
- ② Cut and remove the ceiling members.
- ③ Reinforce the ceiling members, and add other members for fixing the ceiling boards.

5. Installing the unit

5.1. Hanging the unit body

- ▶ Bring the indoor unit to an installation site as it is packed.
- ▶ To hang the indoor unit, use a lifting machine to lift and pass through the hanging bolts.

[Fig. 5-1-1] (P.3)

- Ⓐ Unit body
- Ⓑ Lifting machine

[Fig. 5-1-2] (P.3)

- Ⓒ Nuts (field supply)
- Ⓓ Washers (accessory)
- Ⓔ M10 hanging bolt (field supply)

5.2. Confirming the unit's position and fixing hanging bolts

- ▶ Ensure that the hanging bolt nuts are tightened to fix the hanging bolts.
- ▶ To ensure that drain is discharged, be sure to hang the unit at level using a level.

⚠ **Caution:**

Install the unit in horizontal position. If the side with drain port is installed higher, water leakage may be caused.

6. Refrigerant piping work

6.1. Refrigerant pipe

[Fig. 6-1] (P.4)

- Ⓐ Indoor unit
- Ⓑ Outdoor unit

Refer to the Instruction Manual that came with the outdoor unit for the restrictions on the height difference between units and for the amount of additional refrigerant charge.

Avoid the following places for installation where air conditioner trouble is liable to occur.

- Where there is too much oil such as for machine or cooking.
- Salty environment as seaside areas.
- Hot-spring areas.
- Where sulfide gas exists.
- Other special atmospheric areas.
- This unit has flared connections on both indoor and outdoor sides. [Fig. 6-1]
- Insulate both refrigerant and drainage piping completely to prevent condensation.

Piping preparation

- Refrigerant pipes of 3, 5, 7, 10 and 15 m are available as optional items.

(1) Table below shows the specifications of pipes commercially available.

Model	Pipe	Outside diameter		Min wall thickness	Insulation thickness	Insulation material
		mm	inch			
PEAD-M50	For liquid	6.35	1/4	0.8 mm	8 mm	Heat resisting foam plastic 0.045 specific gravity
	For gas	12.7	1/2	0.8 mm	8 mm	
PEAD-M60, 71	For liquid	9.52	3/8	0.8 mm	8 mm	
	For gas	15.88	5/8	1.0 mm	8 mm	
PEAD-M100	For liquid	9.52	3/8	0.8 mm	8 mm	
	For gas	15.88	5/8	1.0 mm	8 mm	
PEAD-M125	For liquid	9.52	3/8	0.8 mm	8 mm	
	For gas	15.88	5/8	1.0 mm	8 mm	
PEAD-M140	For liquid	9.52	3/8	0.8 mm	8 mm	
	For gas	15.88	5/8	1.0 mm	8 mm	

(2) Ensure that the 2 refrigerant pipes are well insulated to prevent condensation.

(3) Refrigerant pipe bending radius must be 10 cm or more.

⚠ **Caution:**

Using careful insulation of specified thickness. Excessive thickness prevents storage behind the indoor unit and smaller thickness causes dew drippage.

6. Refrigerant piping work

6.2. Flaring work

- Main cause of gas leakage is defect in flaring work.
Carry out correct flaring work in the following procedure.

6.2.1. Pipe cutting

[Fig. 6-2-1] (P.4)

- Ⓐ Copper tubes
- Ⓑ Good
- Ⓒ No good
- Ⓓ Tilted
- Ⓔ Uneven
- ⓫ Burred

- Using a pipe cutter cut the copper tube correctly.

6.2.2. Burrs removal

[Fig. 6-2-2] (P.4)

- Ⓐ Burr
- Ⓑ Copper tube/pipe
- Ⓒ Spare reamer
- Ⓓ Pipe cutter

- Completely remove all burrs from the cut cross section of pipe/tube.
- Put the end of the copper tube/pipe to downward direction as you remove burrs in order to avoid burrs drop in the tubing.

6.2.3. Putting nut on

[Fig. 6-2-3] (P.4)

- Ⓐ Flare nut
- Ⓑ Copper tube

- Remove flare nuts attached to indoor and outdoor unit, then put them on pipe/tube having completed burr removal.
(not possible to put them on after flaring work)
- Use the flare nut included with this indoor unit.

6.2.4. Flaring work

[Fig. 6-2-4] (P.4)

- Ⓐ Flaring tool
- Ⓑ Die
- Ⓒ Copper tube
- Ⓓ Flare nut
- Ⓔ Yoke

- Carry out flaring work using flaring tool as shown below.

Pipe diameter (mm)	Dimension	
	A (mm)	B ⁺⁰ _{-0.4} (mm)
	When the tool for R32/R410A is used	
	Clutch type	
6.35	0 – 0.5	9.1
9.52	0 – 0.5	13.2
12.7	0 – 0.5	16.6
15.88	0 – 0.5	19.7

Firmly hold copper tube in a die in the dimension shown in the table at above.

- When reconnecting the detached refrigerant pipes, make sure to flare them again.

6.2.5. Check

[Fig. 6-2-5] (P.4)

- Ⓐ Smooth all around
- Ⓑ Inside is shining without any scratches
- Ⓒ Even length all around
- Ⓓ Too much
- Ⓔ Tilted
- ⓫ Scratch on flared plane
- ⓬ Cracked
- ⓭ Uneven
- ⓮ Bad examples

- Compare the flared work with a figure in right side hand.
- If flare is noted to be defective, cut off the flared section and do flaring work again.

6.3. Pipe connection

[Fig. 6-3-1] (P.4)

- Apply a thin coat of refrigeration oil on the seat surface of pipe.
- For connection first align the center, then tighten the first 3 to 4 turns of flare nut.
- Use tightening torque table below as a guideline for indoor unit side union joint section, and tighten using two wrenches. Excessive tightening damages the flare section.

Copper pipe O.D. (mm)	Flare nut O.D. (mm)	Tightening torque (N·m)
ø 6.35	17	14 – 18
ø 9.52	22	34 – 42
ø 12.7	26	49 – 61
ø 15.88	29	68 – 82

⚠ Warning:

Be careful of flying flare nut! (Internally pressurized)

Remove the flare nut as follows:

- Loosen the nut until you hear a hissing noise.
- Do not remove the nut until the gas has been completely released (i.e., hissing noise stops).
- Check that the gas has been completely released, and then remove the nut.

Outdoor unit connection

Connect pipes to stop valve pipe joint of the outdoor unit in the same manner applied for indoor unit.

- For tightening use a torque wrench or spanner, and use the same tightening torque applied for indoor unit.

Refrigerant pipe insulation

- After connecting refrigerant piping, insulate the joints (flared joints) with thermal insulation tubing as shown below.

[Fig. 6-3-2] (P.4)

- Ⓐ Pipe cover (small) (accessory)

Ⓑ Caution:

Pull out the thermal insulation on the refrigerant piping at the site, insert the flare nut to flare the end, and replace the insulation in its original position.

Take care to ensure that condensation does not form on exposed copper piping.

- Ⓒ Liquid end of refrigerant piping
- Ⓓ Site refrigerant piping
- Ⓔ Pipe cover (large) (accessory)
- ⓫ Pull
- ⓬ Return to original position
- ⓭ Plate on main body
- ⓮ Ensure that there is no gap here. Place join upwards.
- ⓯ Gas end of refrigerant piping
- ⓰ Main body
- ⓱ Thermal insulation (field supply)
- ⓲ Flare nut
- ⓳ Ensure that there is no gap here
- ⓴ Band (accessory)

- Remove and discard the rubber bung which is inserted in the end of the unit piping.
- Flare the end of the site refrigerant piping.
- Pull out the thermal insulation on the site refrigerant piping and replace the insulation in its original position.

Cautions On Refrigerant Piping

- Be sure to use non-oxidative brazing for brazing to ensure that no foreign matter or moisture enter into the pipe.
- Be sure to apply refrigerating machine oil over the flare connection seating surface and tighten the connection using a double spanner.
- Provide a metal brace to support the refrigerant pipe so that no load is imparted to the indoor unit end pipe. This metal brace should be provided 50 cm away from the indoor unit's flare connection.

6. Refrigerant piping work

6.4. Purging procedures leak test

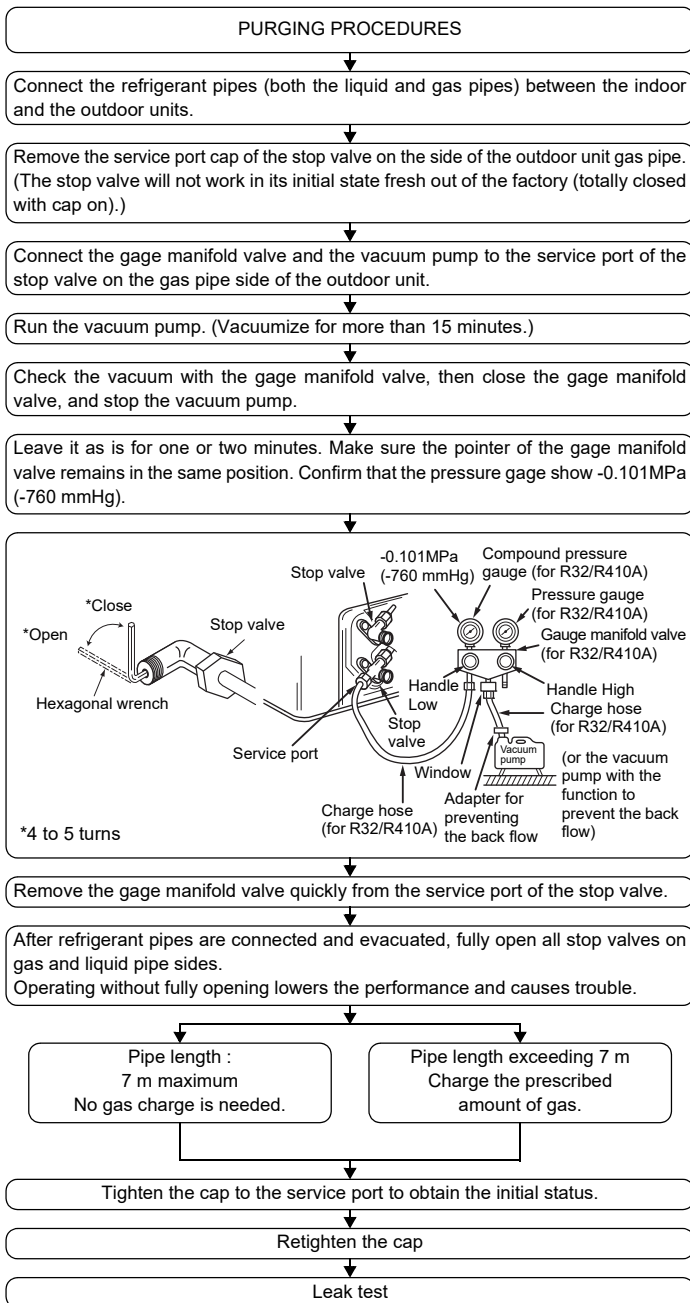

6.5. Drain piping work

- Ensure that the drain piping is downward (pitch of more than 1/100) to the outdoor (discharge) side. Do not provide any trap or irregularity on the way.
- Ensure that any cross-wise drain piping is less than 20 m (excluding the difference of elevation). If the drain piping is long, provide metal braces to prevent it from waving. Never provide any air vent pipe. Otherwise drain may be ejected.
- Use a hard vinyl chloride pipe VP-25 (with an external diameter of 32 mm) for drain piping.
- Ensure that collected pipes are 10 cm lower than the unit body's drain port.
- Do not provide any odor trap at the drain discharge port.
- Put the end of the drain piping in a position where no odor is generated.
- Do not put the end of the drain piping in any drain where ionic gases are generated.

[Fig. 6-5-1] (P.5)

- Correct piping
- × Wrong piping
- Ⓐ Insulation (9 mm or more)
- Ⓑ Downward slope (1/100 or more)
- Ⓒ Support metal
- Ⓓ Air bleeder
- Ⓔ Raised
- Ⓜ Odor trap

Grouped piping

- Ⓓ O. D. ø32 PVC TUBE
- Ⓔ Make it as large as possible. About 10 cm.
- Ⓕ Indoor unit
- Ⓖ Make the piping size large for grouped piping.
- Ⓗ Downward slope (1/100 or more)
- Ⓛ O. D. ø38 PVC TUBE for grouped piping. (9 mm or more insulation)

PEAD-M-JAAD model

- Ⓜ Up to 700 mm
- Ⓝ Drain hose (accessory)
- Ⓞ Horizontal or slightly upgradient

[PEAD-M-JAAD model]

1. Insert the drain hose (accessory) into the drain port (insertion margin: 25 mm). (The drain hose must not be bent more than 45° to prevent the hose from breaking or clogging.) (Attach the hose with glue, and fix it with the band (small, accessory).)
2. Attach the drain pipe (O.D. ø32 PVC TUBE PV-25, field supply). (Attach the pipe with glue, and fix it with the band (small, accessory).)
3. Perform insulation work on the drain pipe (O.D. ø32 PVC TUBE PV-25) and on the socket (including elbow).
4. Check the drainage. (Refer to [Fig. 6-6])
5. Attach the insulating material (accessory), and fix it with the band (large, accessory) to insulate the drain port.

[Fig. 6-5-2] (P.5) *only on the PEAD-M-JAAD model

- Ⓐ Indoor unit
- Ⓑ Tie band (accessory)
- Ⓒ Visible part
- Ⓓ Insertion margin
- Ⓔ Drain hose (accessory)
- Ⓕ Drain pipe (O.D. ø32 PVC TUBE, field supply)
- Ⓖ Insulating material (field supply)
- Ⓗ Tie band (accessory)
- Ⓛ To be gap free. The joint section of the insulation material meet must be at the top.

[PEAD-M-JAA model]

1. Insert the drain hose (accessory) into the drain port. (The drain hose must not be bent more than 45° to prevent the hose from breaking or clogging.) The connecting part between the indoor unit and the drain hose may be disconnected at the maintenance. Fix the part with the accessory band, not be adhered.
2. Attach the drain pipe (O.D. ø32 PVC TUBE, field supply). (Attach the pipe with glue for the hard vinyl chloride pipe, and fix it with the band (small, accessory).)
3. Perform insulation work on the drain pipe (O.D. ø32 PVC TUBE) and on the socket (including elbow).

[Fig. 6-5-3] (P.5) *only on the PEAD-M-JAA model

- Ⓐ Indoor unit
- Ⓑ Tie band (accessory)
- Ⓒ Band fixing part
- Ⓓ Insertion margin
- Ⓔ Drain hose (accessory)
- Ⓕ Drain pipe (O.D. ø32 PVC TUBE, field supply)
- Ⓖ Insulating material (field supply)

6. Refrigerant piping work

6.6. Confirming drain discharge

▶ **Make sure that the drain-up mechanism operates normally for discharge and that there is no water leakage from the connections.**

- Be sure to confirm the above in a period of heating operation.
- Be sure to confirm the above before ceiling work is done in the case of a new construction.

1. Remove the water supply port cover on the same side as the indoor unit piping.
2. Fill water into the feed water pump using a feed water tank. In filling, be sure to put the end of the pump or tank in a drain pan. (If the insertion is incomplete, water may flow over the machine.)
3. Perform the test run in cooling mode, or connect the connector to the ON side of SWE on the Indoor controller board. (The drain pump and the fan are forced to operate without any remote controller operation.) Make sure using a transparent hose that drain is discharged.

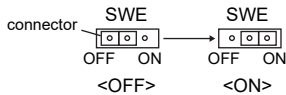

4. After confirmation, cancel the test run mode, and turn off the main power. If the connector is connected to the ON side of SWE, disconnect it and connect it to the OFF side, and attach the water supply port cover into its original position.

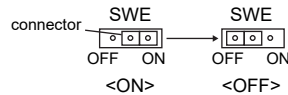

[Fig. 6-6] (P.5)

- Ⓐ Insert pump's end 2 to 4 cm.
- Ⓑ Remove the water supply port.
- Ⓒ About 2500 cc
- Ⓓ Water
- Ⓔ Filling port
- Ⓕ Screw

7. Duct work

- Connect canvas duct between unit and duct. [Fig. 7-1] (P.6)
- Use incombustible material for duct parts.
- Provide full insulation to inlet duct flange and outlet duct to prevent condensation.
- Be sure to change the position of air filter to a position where it can be serviced.

<A> In case of rear inlet
 In case of bottom inlet

- Ⓐ Duct
- Ⓑ Air inlet
- Ⓒ Access door
- Ⓓ Canvas duct
- Ⓔ Ceiling surface
- Ⓕ Air outlet
- Ⓖ Leave distance enough to prevent short cycle

- Procedure for changing the rear inlet to the bottom inlet. [Fig. 7-2] (P.6)

- Ⓐ Filter
- Ⓑ Bottom plate

1. Remove air filter. (First remove filter lock screw.)
2. Remove the bottom plate.
3. Fit the bottom plate to the rear of the body. [Fig. 7-3] (P.6)
(Position of lug-holes on the plate are different from those for rear inlet.)

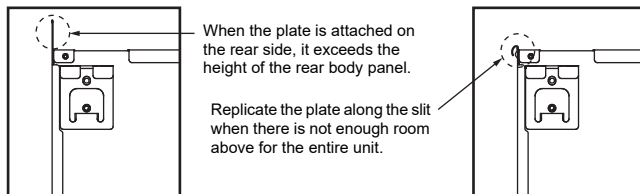

4. Fit filter to the underside of the body.
(Be careful of which side of the filter to fit.) [Fig. 7-4] (P.6)

- Ⓒ Nail for the bottom inlet
- Ⓓ Nail for the rear inlet

⚠ Caution:

- **Inlet duct of 850 mm or more should be constructed.**
To connect the air conditioner main body and the duct for potential equalization.
- **To reduce the risk of injury from metal sheet edges, wear protective gloves.**
- **To connect the air conditioner main body and the duct for potential equalization.**
- **The noise from the intake will increase dramatically if intake is fitted directly beneath the main body. Intake should therefore be installed as far away from the main body as possible.**
Particular care is required when using it with bottom inlet specifications.
- **Install sufficient thermal insulation to prevent condensation forming on outlet duct flanges and outlet ducts.**
- **Keep the distance between the inlet grille and the fan over 850 mm.**
If it is less than 850 mm, install a safety guard not to touch the fan.
- **To avoid electrical noise interference, do not run transmission lines at the bottom of the unit.**

8. Electrical work

8.1. Power supply

8.1.1. Indoor unit power supplied from outdoor unit

The following connection patterns are available.

The outdoor unit power supply patterns vary on models.

1:1 System

[Fig. 8-1-1] (P.6)

- Ⓐ Outdoor unit power supply
- Ⓑ Earth leakage breaker
- Ⓒ Wiring circuit breaker or isolating switch
- Ⓓ Outdoor unit
- Ⓔ Indoor unit/outdoor unit connecting cords
- Ⓕ Remote controller (option)
- Ⓖ Indoor unit

* Affix a label A that is included with the manuals near each wiring diagram for the indoor and outdoor units.

Simultaneous twin/triple/four system

[Fig. 8-1-2] (P.6)

- Ⓐ Outdoor unit power supply
- Ⓑ Earth leakage breaker
- Ⓒ Wiring circuit breaker or isolating switch
- Ⓓ Outdoor unit
- Ⓔ Indoor unit/outdoor unit connecting cords
- Ⓕ Remote controller (option)
- Ⓖ Indoor unit

* Affix a label A that is included with the manuals near each wiring diagram for the indoor and outdoor units.

Field electrical wiring

Indoor unit model		PEAD
Wiring Wire No. x size (mm ²)	Indoor unit power supply (Heater)	—
	Indoor unit power supply (Heater) earth	—
	Indoor unit-Outdoor unit	3 × 1.5 (polar)
	Indoor unit-Outdoor unit earth	1 × Min. 1.5
Circuit rating	Remote controller-Indoor unit	*1 2 × 0.3 (Non-polar)
	Indoor unit (Heater) L-N	*2 —
	Indoor unit-Outdoor unit S1-S2	*2 230 V AC
	Indoor unit-Outdoor unit S2-S3	*2 24 V DC
	Remote controller-Indoor unit	*2 14 V DC

*1. The 10 m wire is attached in the remote controller accessory. Max. 500 m

*2. The figures are NOT always against the ground.

S3 terminal has 24 V DC against S2 terminal. However between S3 and S1, these terminals are not electrically insulated by the transformer or other device.

- Notes:**
1. Wiring size must comply with the applicable local and national code.
 2. Power supply cords and indoor unit/outdoor unit connecting cords shall not be lighter than polychloroprene sheathed flexible cord. (Design 245 IEC57)
 3. Install an earth longer than other cables.
 4. Indoor and outdoor connecting wires have polarities. Make sure to match the terminal number (S1, S2, S3) for correct wirings.
 5. Wiring for remote controller cable shall be apart (5 cm, 2 inch or more) from power source wiring so that it is not influenced by electric noise from power source wiring.

8.1.2. Separate indoor unit/outdoor unit power supplies (For PUHZ application only)

The following connection patterns are available.

The outdoor unit power supply patterns vary on models.

1:1 System

* The optional wiring replacement kit is required.

[Fig. 8-1-3] (P.6)

- Ⓐ Outdoor unit power supply
- Ⓑ Earth leakage breaker
- Ⓒ Wiring circuit breaker or isolating switch
- Ⓓ Outdoor unit
- Ⓔ Indoor unit/outdoor unit connecting cords
- Ⓕ Remote controller (option)
- Ⓖ Indoor unit
- Ⓗ Option
- Ⓙ Indoor unit power supply

* Affix a label B that is included with the manuals near each wiring diagram for the indoor and outdoor units.

Simultaneous twin/triple/four system

* The optional wiring replacement kits are required.

[Fig. 8-1-4] (P.6)

- Ⓐ Outdoor unit power supply
- Ⓑ Earth leakage breaker
- Ⓒ Wiring circuit breaker or isolating switch
- Ⓓ Outdoor unit
- Ⓔ Indoor unit/outdoor unit connecting cords
- Ⓕ Remote controller (option)
- Ⓖ Indoor unit
- Ⓗ Option
- Ⓙ Indoor unit power supply

* Affix a label B that is included with the manuals near each wiring diagram for the indoor and outdoor units.

If the indoor and outdoor units have separate power supplies, refer to the table at the below. If the optional wiring replacement kit is used, change the indoor unit electrical box wiring referring to the figure in the right and the DIP switch settings of the outdoor unit control board.

Indoor unit specifications									
Indoor power supply terminal kit (option)	Required								
Indoor unit electrical box connector connection change	Required								
Label affixed near each wiring diagram for the indoor and outdoor units	Required								
Outdoor unit DIP switch settings (when using separate indoor unit/outdoor unit power supplies only)	<table border="1" style="display: inline-table;"> <tr> <td>ON</td> <td></td> <td></td> <td>3</td> </tr> <tr> <td>OFF</td> <td>1</td> <td>2</td> <td></td> </tr> </table> (SW8)	ON			3	OFF	1	2	
ON			3						
OFF	1	2							

* There are three types of labels (labels A, B, and C). Affix the appropriate labels to the units according to the wiring method.

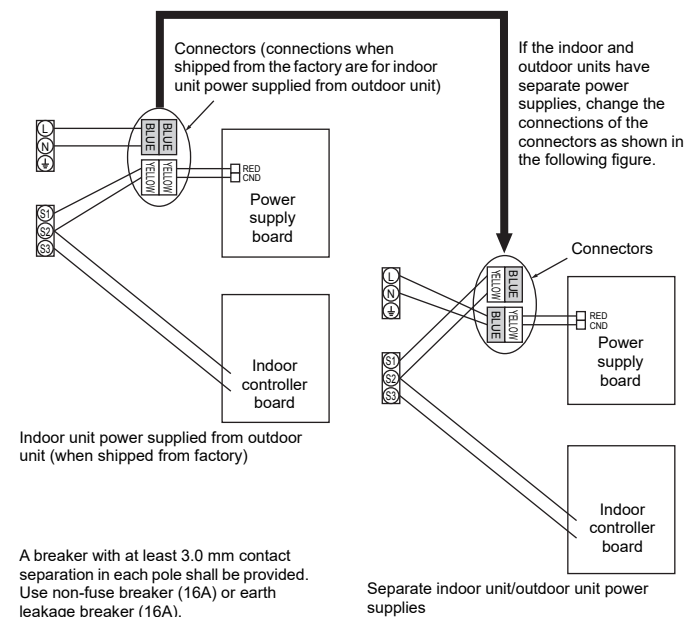

8. Electrical work

8.2. Indoor wire connection

Work procedure

1. Remove 2 screws to detach the electric component cover.
2. Route each cable through the wiring intake into the electric component box. (Procure power cable and in-out connecting cable locally and use remote control cable supplied with the unit.)
3. Securely connect the power cable and the in-out connecting cable and the remote control cable to the terminal blocks.
4. Secure the cables with clamps inside the electric component box.
5. Attach the electric component cover as it was.
 - Fix power supply cable and indoor/outdoor cable to control box by using buffer bushing for tensile force. (PG connection or the like.)

⚠ Warning:

- **Attach the electrical part cover securely. If it is attached incorrectly, it could result in a fire, electric shock due to dust, water, etc.**
- **Use the specified indoor/outdoor unit connecting wire to connect the indoor and outdoor units and fix the wire to the terminal block securely so that no stress is applied to the connecting section of the terminal block. Incomplete connection or fixing of the wire could result in a fire.**

[Fig. 8-2-1] (P.7)

- Ⓐ Screw holding cover (1pc)
- Ⓑ Cover

[Fig. 8-2-2] (P.7)

- Ⓒ Terminal box
- Ⓓ Knockout hole
- Ⓔ Remove

[Fig. 8-2-3] (P.7)

- Ⓕ Use PG bushing to keep the weight of the cable and external force from being applied to the power supply terminal connector. Use a cable tie to secure the cable.
- Ⓖ Power source wiring
- Ⓗ Use ordinary bushing
- Ⓘ Transmission wiring

[Fig. 8-2-4] (P.7)

- Ⓙ Terminal block for power source and indoor transmission
- Ⓚ Terminal block for remote controller

- Perform wiring as shown in [Fig. 8-2-4]. (Procure the cable locally.)
Make sure to use cables of the correct polarity only.

[Fig. 8-2-5] (P.7)

- Ⓐ Indoor terminal block
- Ⓑ Earth wire (green/yellow)
- Ⓒ Indoor/outdoor unit connecting wire 3-core 1.5 mm² or more
- Ⓓ Outdoor terminal block
- Ⓔ Power supply cord : 2.0 mm² or more
- ① Connecting cable
Cable 3-core 1.5 mm², in conformity with Design 245 IEC 57.
- ② Indoor terminal block
- ③ Outdoor terminal block
- ④ Always install an earth wire (1-core 1.5 mm²) longer than other cables
- ⑤ Remote controller cable
Wire No × size (mm²) : Cable 2C × 0.3
This wire accessory of remote controller
(wire length : 10 m, non-polar. Max. 500 m)
- ⑥ Wired remote controller (option)
- ⑦ Power supply cord
Cable 3-core 2.0 mm² or more, in conformity with Design 245 IEC 57.

- Connect the terminal blocks as shown in [Fig. 8-2-5].

⚠ Caution:

- **Use care not to make mis-wiring.**
- **Firmly tighten the terminal screws to prevent them from loosening.**
- **After tightening, pull the wires lightly to confirm that they do not move.**

8.3. Remote controller (wired remote controller (option))

8.3.1. For wired remote controller

1) Installing procedures

Refer to the installation manual that comes with each remote controller for details.

2) Function selection of remote controller

If two remote controllers are connected, set one to "Main" and the other to "Sub". For setting procedures, refer to "Function selection of remote controller" in the operation manual for the indoor unit.

8.4. Remote controller (wireless remote controller (option))

8.4.1. For wireless remote controller (option)

1) Installation area

- Area in which the remote controller is not exposed to direct sunshine.
- Area in which there is no near by heating source.
- Area in which the remote controller is not exposed to cold (or hot) winds.
- Area in which the remote controller can be operated easily.
- Area in which the remote controller is beyond the reach of children.

* The signal can travel up to approximately 7 meters (in a straight line) within 45 degrees to both right and left of the center line of the receiver.

2) Installing procedures

Refer to the installation manual that comes with each remote controller for details.

8.4.2. Signal Receiving Unit

1) Sample system connection

[Fig. 8-4-1] (P.8)

- Indoor/outdoor wiring
- Signal receiving unit wiring
- Ⓐ Outdoor unit
- Ⓑ Refrigerant address
- Ⓒ Indoor unit
- Ⓓ Signal receiving unit

Only the wiring from the signal receiving unit and between the remote controllers is shown in [Fig. 8-4-1]. The wiring differs depending on the unit to be connected or the system to be used.

For details on restrictions, refer to the installation manual or the service handbook that came with the unit.

1. Connecting to Mr. SLIM air conditioner

(1) Standard 1:1

① Connecting the signal receiving unit

Connect the signal receiving unit to the CN90 (Connect to the wireless remote controller board) on the indoor unit using the supplied remote controller wire. Connect the signal receiving units to all the indoor units.

2) Installing procedures

Refer to the installation manual that comes with each remote controller for details.

8.4.3. Setting

1) Setting the pair number switch

[Fig. 8-4-2] (P.8)

<Indoor controller board>

1. Setting method

Assign the same pair number to the wireless remote controller as that of the indoor unit. If not doing so, the remote controller cannot be operated. Refer to the installation manual that came with the wireless remote controller for how to set pair numbers of wireless remote controllers.

Position of daisy wire on the controller circuit board on the indoor unit.

Controller circuit board on the indoor unit (reference)

[Fig. 8-4-2] (P.8)

- Ⓐ CN90: Connector for remote controller wire connection
- Ⓑ The figure at left shows that the switches 1 through 5 are set to ON and 6 through 10 are set to OFF.

For pair number settings, the following 4 patters (A-D) are available.

Pair number setting pattern	Pair number on remote controller side	Indoor controller circuit board side Point where the daisy wire is disconnected
A	0	Not disconnected
B	1	J41 disconnected
C	2	J42 disconnected
D	3~9	J41 and J42 disconnected

8. Electrical work

2. Setting example

(1) To use the units in the same room

[Fig. 8-4-3] (P.8)

① Separate setting

Assign a different pair number to each indoor unit to operate each indoor unit by its own wireless remote controller.

[Fig. 8-4-4] (P.8)

② Single setting

Assign the same pair number to all the indoor units to operate all the indoor units by a single wireless remote controller.

[Fig. 8-4-5] (P.8)

(2) To use the units in different rooms

Assign the same pair number to the wireless remote controller as that of the indoor unit. (Leave the setting as it is at purchase.)

2) Setting the Model No.

① Insert batteries.

② Press the SET button with something sharp at the end.

MODEL SELECT blinks and Model No. lighted.

③ Press the temp **M** **A** button to set the Model No.

④ Press the SET button with something sharp at the end.

MODEL SELECT and Model No. are lighted for three seconds, then turned off.

Indoor Unit Model	Model No.
PEAD	026

8.5. Function settings

8.5.1. For wired remote controller

① **[Fig. 8-5-1] (P.9)**

- Select "Service" from the Main menu, and press the [SELECT] button.
- Select "Function setting" with the [F1] or [F2] button, and press the [SELECT] button.

② **[Fig. 8-5-2] (P.9)**

- Set the indoor unit refrigerant addresses and unit numbers with the [F1] through [F4] buttons, and then press the [SELECT] button to confirm the current setting.

<Checking the Indoor unit No.>

When the [SELECT] button is pressed, the target indoor unit will start fan operation. If the unit is common or when running all units, all indoor units for the selected refrigerant address will start fan operation.

③ **[Fig. 8-5-3] (P.9)**

- When data collection from the indoor units is completed, the current settings appears highlighted. Non-highlighted items indicate that no function settings are made. Screen appearance varies depending on the "Unit No." setting.

④ **[Fig. 8-5-4] (P.9)**

- Use the [F1] or [F2] button to move the cursor to select the mode number, and change the setting number with the [F3] or [F4] button.

⑤ **[Fig. 8-5-5] (P.9)**

- When the settings are completed, press the [SELECT] button to send the setting data from the remote controller to the indoor units.
- When the transmission is successfully completed, the screen will return to the Function setting screen.

8.5.2. For wireless remote controller

[Fig. 8-5-6] (P.9)

- Ⓐ Hour button
- Ⓑ Minute button
- Ⓒ TEMP button
- Ⓓ TEMP button
- Ⓔ ON/OFF button
- Ⓕ CHECK button

1. Changing the external static pressure setting.

- Be sure to change the external static pressure setting depending on the duct and the grill used.

① Go to the function select mode

Press the CHECK button **Ⓕ** twice continuously.

(Start this operation from the status of remote controller display turned off.)

CHECK is lighted and "00" blinks.

Press the TEMP button **Ⓒ** once to set "50". Direct the wireless remote controller toward the receiver of the indoor unit and press the Hour button **Ⓐ**.

② Setting the unit number

Press the TEMP button **Ⓒ** and **Ⓓ** to set the unit number to 01-04 or AL. Direct the wireless remote controller toward the receiver of the indoor unit and press the Minute button **Ⓑ**.

③ Selecting a mode

Enter 08 to change the external static pressure setting using the **Ⓒ** and **Ⓓ** buttons.

Direct the wireless remote controller toward the receiver of the indoor unit and press the Hour button **Ⓐ**.

- Current setting number: 1 = 1 beep (one second)
 2 = 2 beeps (one second each)
 3 = 3 beeps (one second each)

④ Selecting the setting number

Use the **Ⓒ** and **Ⓓ** buttons to change the external static pressure setting to be used.

Direct the wireless remote controller toward the sensor of the indoor unit and press the Hour button **Ⓐ**.

⑤ To set the external static pressure

Repeat steps ③ and ④ to set the mode number to 10.

⑥ Complete function selection

Direct the wireless remote controller toward the sensor of the indoor unit and press the ON/OFF button **Ⓔ**.

Note:

- **Whenever changes are made to the function settings after installation or maintenance, be sure to record the changes with a mark in the "Check" column of the Function table.**

8.5.3. Changing the power voltage setting (Function table 1)

- Be sure to change the power voltage setting depending on the voltage used.

8. Electrical work

Function table 1

Select unit number 00

Mode	Settings	Mode no.	Setting no.	Initial setting	Check
Power failure automatic recovery (AUTO RESTART FUNCTION)	Not available	01	1	*2	
	Available *1		2	*2	
Indoor temperature detecting	Indoor unit operating average	02	1	○	
	Set by indoor unit's remote controller		2		
	Remote controller's internal sensor		3		
LOSSNAY connectivity	Not Supported	03	1	○	
	Supported (indoor unit is not equipped with outdoor-air intake)		2		
	Supported (indoor unit is equipped with outdoor-air intake)		3		
Power voltage	240V	04	1		
	220V, 230V		2	○	
Auto mode	Energy saving cycle automatically enabled	05	1	○	
	Energy saving cycle automatically disabled		2		

Function table 2

Select unit numbers 01 to 04 or all units (AL [wired remote controller]/07 [wireless remote controller])

Mode	Settings	Mode no.	Setting no.	Initial setting	Check
Filter sign	100 Hr	07	1		
	2500 Hr		2		
	No filter sign indicator		3	○	
External static pressure	External static pressure	08	1		
	35 Pa		2	1	
	50 Pa (before shipment)		3	1	
	70 Pa	10	1	○	
	100 Pa		2	2	
	150 Pa		3	2	

*1 When the power supply returns, the air conditioner will start 3 minutes later.

*2 Power failure automatic recovery initial setting depends on the connecting outdoor unit.

Note: When the function of an indoor unit were changed by function selection after the end of installation, always indicate the contents by entering a ○ or other mark in the appropriate check filed of the tables.

9. Test run

9.1. Before test run

- ▶ After completing installation and the wiring and piping of the indoor and outdoor units, check for refrigerant leakage, looseness in the power supply or control wiring, wrong polarity, and no disconnection of one phase in the supply.
- ▶ Use a 500-volt megohmmeter to check that the resistance between the power supply terminals and ground is at least 1.0 MΩ.
- ▶ Do not carry out this test on the control wiring (low voltage circuit) terminals.

⚠ Warning:

Do not use the air conditioner if the insulation resistance is less than 1.0 MΩ. Insulation resistance

After installation or after the power source to the unit has been cut for an extended period, the insulation resistance will drop below 1 MΩ due to refrigerant accumulating in the compressor. This is not a malfunction. Perform the following procedures.

1. Remove the wires from the compressor and measure the insulation resistance of the compressor.
2. If the insulation resistance is below 1 MΩ, the compressor is faulty or the resistance dropped due the accumulation of refrigerant in the compressor.

3. After connecting the wires to the compressor, the compressor will start to warm up after power is supplied. After supplying power for the times indicated below, measure the insulation resistance again.
 - The insulation resistance drops due to accumulation of refrigerant in the compressor. The resistance will rise above 1 MΩ after the compressor is warmed up for two to three hours. (The time necessary to warm up the compressor varies according to atmospheric conditions and refrigerant accumulation.)
 - To operate the compressor with refrigerant accumulated in the compressor, the compressor must be warmed up at least 12 hours to prevent breakdown.
4. If the insulation resistance rises above 1 MΩ, the compressor is not faulty.

⚠ Caution:

The compressor will not operate unless the power supply phase connection is correct.

- Turn on the power at least 12 hours before starting operation.

- Starting operation immediately after turning on the main power switch can result in severe damage to internal parts. Keep the power switch turned on during the operational season.

9.2. Test run

9.2.1. Using wired remote controller

- Make sure to read operation manual before test run. (Especially items to secure safety)

Step 1 Turn on the power.

- Remote controller: The system will go into startup mode, and the remote controller power lamp (green) and "PLEASE WAIT" will blink. While the lamp and message are blinking, the remote controller cannot be operated. Wait until "PLEASE WAIT" is not displayed before operating the remote controller. After the power is turned on, "PLEASE WAIT" will be displayed for approximately 2 minutes.
- Indoor controller board: LED 1 will be lit up, LED 2 will be lit up (if the address is 0) or off (if the address is not 0), and LED 3 will blink.
- Outdoor controller board: LED 1 (green) and LED 2 (red) will be lit up. (After the startup mode of the system finishes, LED 2 will be turned off.) If the outdoor controller board uses a digital display, [-] and [-] will be displayed alternately every second.

If the operations do not function correctly after the procedures in step 2 and thereafter are performed, the following causes should be considered and eliminated if they are found.

(The symptoms below occur during the test run mode. "Startup" in the table means the LED display written above.)

Symptoms in test run mode		Cause
Remote Controller Display	OUTDOOR BOARD LED Display < > indicates digital display.	
Remote controller displays "PLEASE WAIT", and cannot be operated.	After "startup" is displayed, only green lights up. <00>	• After power is turned on, "PLEASE WAIT" is displayed for 2 minutes during system startup. (Normal)
After power is turned on, "PLEASE WAIT" is displayed for 3 minutes, then error code is displayed.	After "startup" is displayed, green(once) and red(once) blink alternately. <F1>	• Incorrect connection of outdoor terminal block. (R, S, T and S1, S2, S3)
	After "startup" is displayed, green(once) and red(twice) blink alternately. <F3, F5, F9>	• Outdoor unit's protection device connector is open.
No display appears even when remote controller operation switch is turned on. (Operation lamp does not light up.)	After "startup" is displayed, green(twice) and red(once) blink alternately. <EA, Eb>	• Incorrect wiring between the indoor and outdoor unit. (Polarity is wrong for S1, S2, S3)
	After "startup" is displayed, only green lights up. <00>	• Remote controller transmission wire short. • There is no outdoor unit of address 0. (Address is other than 0.) • Remote controller transmission wire open.
Display appears but soon disappears even when remote controller is operated.	After "startup" is displayed, only green lights up. <00>	• After canceling function selection, operation is not possible for about 30 seconds. (Normal)

Step 2 Switch the remote controller to "Test run".

- ① Select "Test run" from the Service menu, and press the [SELECT] button. [Fig. 9-2-1] (P.10)
- ② Select "Test run" from the Test run menu, and press the [SELECT] button. [Fig. 9-2-2] (P.10)
- ③ The test run operation starts, and the Test run operation screen is displayed.

Step 3 Perform the test run and check the airflow temperature.

- ① Press the [F1] button to change the operation mode. [Fig. 9-2-3] (P.10)

Cooling mode: Check that cool air blows from the unit.

Heating mode: Check that warm air blows from the unit.

Step 4 Confirm the operation of the outdoor unit fan.

The speed of the outdoor unit fan is controlled in order to control the performance of the unit. Depending on the ambient air, the fan will rotate at a slow speed and will keep rotating at that speed unless the performance is insufficient. Therefore, the outdoor wind may cause the fan to stop rotating or to rotate in the opposite direction, but this is not a problem.

Step 5 Stop the test run.

- ① Press the [ON/OFF] button to stop the test run. (The Test run menu will appear.)

Note: If an error is displayed on the remote controller, see the table below.

9. Test run

• For description of each check code, refer to the following table.

① Check code	Symptom	Remark
P1	Intake sensor error	
P2, P9	Pipe (Liquid or 2-phase pipe) sensor error	
E6, E7	Indoor/outdoor unit communication error	
P4	Drain sensor error	
P5	Drain pump error	
PA	Forced compressor error	
P6	Freezing/Overheating safeguard operation	
EE	Communication error between indoor and outdoor units	
P8	Pipe temperature error	
E4	Remote controller signal receiving error	
Fb	Indoor unit control system error (memory error, etc.)	
E0, E3	Remote controller transmission error	
E1, E2	Remote controller control board error	
E9	Indoor/outdoor unit communication error (Transmitting error) (Outdoor unit)	
UP	Compressor overcurrent interruption	
U3, U4	Open/short of outdoor unit thermistors	
UF	Compressor overcurrent interruption (When compressor locked)	
U2	Abnormal high discharging temperature/49C worked/insufficient refrigerant	
U1, Ud	Abnormal high pressure (63H worked)/Overheating safeguard operation	
U5	Abnormal temperature of heat sink	
U8	Outdoor unit fan safeguard stop	
U6	Compressor overcurrent interruption/Abnormal of power module	
U7	Abnormality of super heat due to low discharge temperature	
U9, UH	Abnormality such as overvoltage or voltage shortage and abnormal synchronous signal to main circuit/ Current sensor error	
Others	Other errors (Refer to the technical manual for the outdoor unit.)	

For details, check the LED display of the outdoor controller board.

• On wired remote controller

① Check code displayed in the LCD.

9.2.2. Using wireless remote controller (option)

[Fig. 9-2-4] (P.10)

- Ⓐ TEST RUN button
- Ⓑ MODE button
- Ⓒ FAN button
- Ⓓ VANE button

- ① Turn on the power to the unit at least 12 hours before the test run.
- ② Press the TEST RUN button Ⓐ twice continuously.
(Start this operation from the status of remote controller display turned off.)
TEST RUN and current operation mode are displayed.
- ③ Press the MODE button Ⓑ to activate COOL mode, then check whether cool air is blown out from the unit.

④ Press the MODE button Ⓑ to activate HEAT mode, then check whether warm air is blown out from the unit.

⑤ Press the FAN button Ⓒ and check whether fan speed changes.

⑥ Press the VANE button Ⓓ and check whether the auto vane operates properly.

⑦ Press the ON/OFF button to stop the test run.

Note:

- Point the remote controller towards the indoor unit receiver while following steps ② to ⑦.
- It is not possible to run the in FAN, DRY or AUTO mode.

[Output pattern A] Errors detected by indoor unit

Wireless remote controller	Wired remote controller	Symptom	Remark
Beeper sounds/OPERATION INDICATOR lamp flashes (Number of times)	Check code		
1	P1	Intake sensor error	
2	P2, P9	Pipe (Liquid or 2-phase pipe) sensor error	
3	E6, E7	Indoor/outdoor unit communication error	
4	P4	Drain sensor error	
5	P5	Drain pump error	
6	P6	Freezing/Overheating safeguard operation	
7	EE	Communication error between indoor and outdoor units	
8	P8	Pipe temperature error	
9	E4	Remote controller signal receiving error	
10	—	—	
11	—	—	
12	Fb	Indoor unit control system error (memory error, etc.)	
14	PL	Refrigerant circuit abnormal	
No sound	—	No corresponding	

9. Test run

[Output pattern B] Errors detected by unit other than indoor unit (outdoor unit, etc.)

Wireless remote controller Beeper sounds/OPERATION INDICATOR lamp flashes (Number of times)	Symptom	Remark
1	Indoor/outdoor unit communication error (Transmitting error) (Outdoor unit)	For details, check the LED display of the outdoor controller board.
2	Compressor overcurrent interruption	
3	Open/short of outdoor unit thermistors	
4	Compressor overcurrent interruption (When compressor locked)	
5	Abnormal high discharging temperature/49C worked/ insufficient refrigerant	
6	Abnormal high pressure (63H worked)/ Overheating safeguard operation	
7	Abnormal temperature of heat sink	
8	Outdoor unit fan protection stop	
9	Compressor overcurrent interruption/Abnormal of power module	
10	Abnormality of super heat due to low discharge temperature	
11	Abnormality such as overvoltage or voltage shortage and abnormal synchronous signal to main circuit/Current sensor error	
12	—	
13	—	
14	Other errors (Refer to the technical manual for the outdoor unit.)	

*1 If the beeper does not sound again after the initial two beeps to confirm the self-check start signal was received and the OPERATION INDICATOR lamp does not come on, there are no error records.

*2 If the beeper sounds three times continuously “beep, beep, beep (0.4 + 0.4 + 0.4 sec.)” after the initial two beeps to confirm the self-check start signal was received, the specified refrigerant address is incorrect.

- On wireless remote controller
The continuous buzzer sounds from receiving section of indoor unit.
Blink of operation lamp
- On wired remote controller
Check code displayed on the LCD.

• If the unit cannot be operated properly after the above test run has been performed, refer to the following table to remove the cause.

Symptom		Cause
Wired remote controller	LED 1, 2 (PCB in outdoor unit)	
PLEASE WAIT	For about 2 minutes following power-on	After LED 1, 2 are lighted, LED 2 is turned off, then only LED 1 is lighted. (Correct operation)
PLEASE WAIT → Error code	After about 2 minutes has expired following power-on	Only LED 1 is lighted. → LED 1, 2 blink.
Display messages do not appear even when operation switch is turned ON (operation lamp does not light up).		Only LED 1 is lighted. → LED 1, 2 blinks twice, LED 2 blinks once.

On the wireless remote controller with conditions above, following phenomena takes place.

- No signals from the remote controller are accepted.
- OPE lamp is blinking.
- The buzzer makes a short ping sound.

Note:

Operation is not possible for about 30 seconds after cancellation of function selection. (Correct operation)

For description of each LED (LED1, 2, 3) provided on the indoor controller, refer to the following table.

LED 1 (power for microcomputer)	Indicates whether control power is supplied. Make sure that this LED is always lit.
LED 2 (power for remote controller)	Indicates whether power is supplied to the remote controller. This LED lights only in the case of the indoor unit which is connected to the outdoor unit refrigerant address “0”.
LED 3 (communication between indoor and outdoor units)	Indicates state of communication between the indoor and outdoor units. Make sure that this LED is always blinking.

9.3. AUTO RESTART FUNCTION

Indoor controller board

This model is equipped with the AUTO RESTART FUNCTION.

When the indoor unit is controlled with the remote controller, the operation mode, set temperature, and the fan speed are memorized by the indoor controller board. The auto restart function sets to work the moment the power has restored after power failure, then, the unit will restart automatically.

Set the AUTO RESTART FUNCTION using the remote controller. (Mode no.01)

10. Maintenance

10.1. Gas charge

[Fig. 10-1] (P.10)

- Ⓐ Indoor unit
- Ⓑ Union
- Ⓒ Liquid pipe
- Ⓓ Gas pipe
- Ⓔ Stop valve
- Ⓕ Outdoor unit
- Ⓖ Refrigerant gas cylinder operating valve
- Ⓗ Refrigerant gas cylinder for R32/R410A with siphon
- Ⓘ Refrigerant (liquid)
- Ⓢ Electronic scale for refrigerant charging
- Ⓚ Charge hose (for R32/R410A)
- Ⓛ Gauge manifold valve (for R32/R410A)
- Ⓜ Service port

1. Connect gas cylinder to the service port of stop valve (3-way).
2. Execute air purge of the pipe (or hose) coming from refrigerant gas cylinder.
3. Replenish specified amount of refrigerant, while running the air conditioner for cooling.

Note:

In case of adding refrigerant, comply with the quantity specified for the refrigerating cycle.

⚠ Caution:

- Do not discharge the refrigerant into the atmosphere.
Take care not to discharge refrigerant into the atmosphere during installation, reinstallation, or repairs to the refrigerant circuit.
- For additional charging, charge the refrigerant from liquid phase of the gas cylinder.
If the refrigerant is charged from the gas phase, composition change may occur in the refrigerant inside the cylinder and the outdoor unit. In this case, ability of the refrigerating cycle decreases or normal operation can be impossible. However, charging the liquid refrigerant all at once may cause the compressor to be locked. Thus, charge the refrigerant slowly.

To maintain the high pressure of the gas cylinder, warm the gas cylinder with warm water (under 40°C) during cold season. But never use naked fire or steam.



**MITSUBISHI
ELECTRIC**



AIR CONDITIONER INDOOR UNIT

MODEL _____

SERVICE REF. _____

OPERATE	<COOLING>						<HEATING>					
RATED VOLTAGE	220		230		240		220		230		240	
FREQUENCY	50	60	50	60	50	60	50	60	50	60	50	60
RATED INPUT<INDOOR ONLY> kW												
RATED CURRENT<INDOOR ONLY> A												

PHASE _____

REFRIGERANT _____

ALLOWABLE PRESSURE _____ MPa

IP CODE _____

WEIGHT _____ kg

SERIAL No. _____

YEAR OF MANUFACTURE _____

MITSUBISHI ELECTRIC CORPORATION

MITSUBISHI ELECTRIC CONSUMER PRODUCTS (THAILAND) CO., LTD.
700/406 MOO 7, TAMBON DON HUA ROH, AMPHUR MUANG, CHONBURI 20000, THAILAND
MADE IN THAILAND

Please be sure to put the contact address/telephone number on
this manual before handing it to the customer.