

Turbo 150

Inline mixed flow fans



- Maximum airflow: 565
- Sound pressure level LpA at 3 m: 44
- Motor type: AC
- Control: Speed switch
- Impeller type: Mixed
- Casing material: Plastic
- Installation in any position
- Cable with mains plug

	Unit of measurement	Turbo 150	
Connected air duct size	mm	150	
Speed	-	2	
Phases	-	1	
Minimum supply voltage	V	230	
Maximum supply voltage	V	230	
Power supply frequency	Hz	50/60	
Rated power	W	42	50
Unit current	A	0.19	0.22
Maximum airflow	m ³ /h	415	565
rotation speed at 50hz	-		
Sound pressure level LpA at 3 m	dB(A)	32	44
Weight	kg	2.95	
Transported air temperature (max)	°C	60	
Ambient air temperature min	°C	0	
Ambient air temperature max	°C	0	
Ingress protection rating	-	IPX4	
Ingress protection rating of the drive	-	IPX4	

Dimensions

$\varnothing D$	$\varnothing D1$	B	H	L
148	187	220	251	289

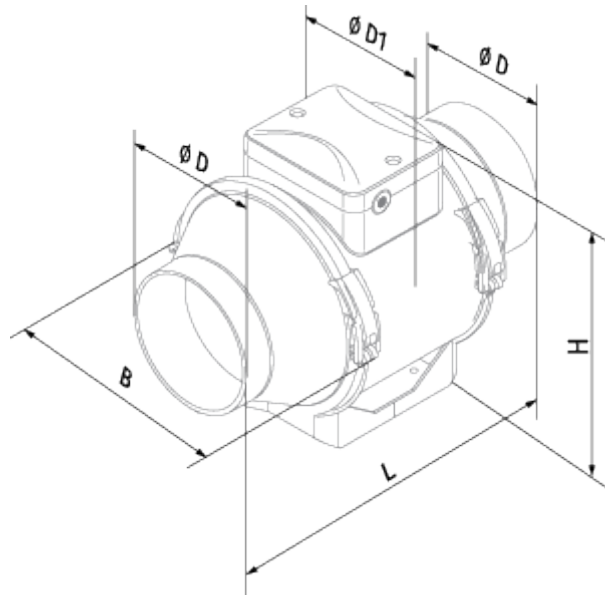

Ecodesign

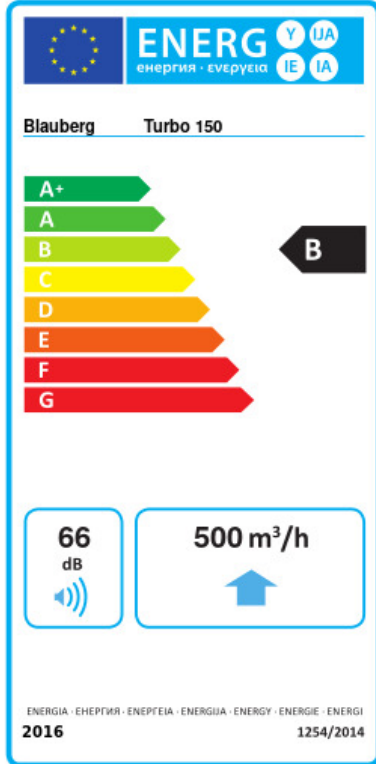

Trademark	Blauberg					
Model	Turbo 150					
Specific energy consumption (SEC) (kWh/(m ² /a))	Cold		Average		Warm	
	53.8	A+	26.7	B	11.2	E
Type of ventilation unit	Unidirectional					
Type of drive installed	Variable speed					
Type of heat recovery system	None					
Maximum flow rate (m ³ /h)	500					
Electric power input (W)	50					
Reference flow rate (m ³ /s)	0.097					
Reference pressure difference (Pa)	50					
Specific power input (SPI) (W/(m ³ /h))	0.12					
Control typology	Local demand control					
Maximum external leakage rates (%)	2.7					
Sound power level (dB(A))	66					
Declared typology	RVU UVU					
The annual electricity consumption (AEC) (kWh/a)	Cold		Average		Warm	
	64		64		64	
The annual heating saved (AHS) (kWh/a)	Cold		Average		Warm	
	5536		2830		1280	